



INSTALLATION AND OPERATION MANUAL

Heat Recovery Unit **OXYGEN X-Air V500**

TABLE OF CONTENTS

| | | |
|--------|--|----|
| 1. | TRANSPORTATION AND STORAGE OF EQUIPEMENT | 3 |
| 2. | UNIT PACKAGE | 4 |
| 3. | SAFETY REQUIREMENTS..... | 5 |
| 4. | EU DECLARATION OF CONFORMITY..... | 6 |
| 5. | TECHNICAL DATA | 7 |
| 5.1. | Product information sheet. Delegated Regulation (EU) 1254/2014 | 7 |
| 5.2. | Performance curves | 8 |
| 5.3. | Performance and power consumption | 8 |
| 5.4. | Sound characteristics | 10 |
| 9.2. | Dimensions and weight..... | 11 |
| 6. | FUNCTIONALITY | 12 |
| 7. | INSTALLATION OF THE UNIT | 13 |
| 7.1. | Selecting the mounting location | 13 |
| 7.2. | Connecting ducts | 13 |
| 7.3. | Maintenance space..... | 14 |
| 7.4. | Connecting the condensate drain..... | 15 |
| 7.5. | Ventilation system balancing..... | 16 |
| 8. | CONNECTION OF THE UNIT | 17 |
| 8.1. | Connecting electric circuit | 18 |
| 8.2. | Installation of the control panel | 18 |
| 8.3. | Connector of comfort functions | 19 |
| 8.4. | Control board electrical wiring diagram | 21 |
| 8.5. | Description of control board contacts | 22 |
| 9. | OPERATION OF THE UNIT..... | 23 |
| 9.1. | WiFi controller | 23 |
| 9.1.1. | Downloading the app | 23 |
| 9.1.2. | WiFi connection set-up..... | 24 |
| 9.1.3. | App home screen..... | 26 |
| 9.1.4. | Setting up weekly operation program..... | 26 |
| 9.1.5. | Ventilation boost activation | 27 |
| 9.1.6. | Away | 27 |
| 9.1.7. | Filter menu | 28 |
| 9.1.8. | Resetting WiFi controller to factory defaults | 28 |
| 9.2. | Control panel with touchscreen display | 29 |
| 9.2.1. | Standby mode..... | 29 |
| 9.2.2. | Main screen | 30 |
| 9.2.3. | Settings menu..... | 31 |
| 9.2.4. | Setting up weekly operation program..... | 32 |
| 9.2.5. | Failure indication | 32 |
| 9.3. | Control panel with a knob..... | 33 |
| 9.3.1. | Operating state indicator | 33 |
| 9.3.2. | Air filter replacing / anti-frost protection indicator | 34 |
| 9.3.3. | Failure indicator..... | 34 |
| 9.3.4. | RESET procedure | 35 |
| 9.3.5. | Resetting the filter lifetime meter | 35 |
| 9.3.6. | Additional system settings | 36 |
| 9.4. | Replacing air filters | 37 |
| 10. | MAINTENANCE AND WARRANTY..... | 39 |
| 11. | CONTACTS..... | 40 |

1. TRANSPORTATION AND STORAGE OF EQUIPEMENT

Heat Recovery Unit (hereinafter – the Unit) is prepared for transportation and storage. Packaging materials ensure protection against exposure to environment, dust and humidity. The Unit must be properly secured during transportation to protect it against possible housing deformation or other mechanical damage.

Transportation conditions: -20°C - +40°C.

Long-term storage conditions: +5°C - +40°C, relative air humidity <= 50%.

CONSIGNMENT ACCEPTANCE:

- Carefully check the received consignment – make sure that the number of packages matches with the consignment documentation. Upon noticing any non-conformity or damage of the package (tears, dents or compressed box, detached or reattached packaging tape), inform the courier immediately and indicate the discrepancies or damages in the consignment document.
- Verify if the right product was delivered. Upon noticing any non-conformity, inform the Sender immediately.
- Verify if all the supplementary parts listed were delivered. In case of any doubt, contact the Sender immediately.
- Do not attempt to repair the Unit, damaged during the transportation by yourself!

IMPORTANT! Sender does not assume any obligations towards damage or loss of the Unit or its part, if there is no a corresponding record in the consignment document!

2. UNIT PACKAGE

| | |
|---|------|
| Heat Recovery Unit OXYGEN X-Air V500 | 1 pc |
| Control panel (10m connection cable included) or WiFi adapter | 1 pc |
| Fastening elements: | |
| Mounting bracket | 1 pc |
| Condensate drain nozzle, Ø32 | 1 pc |
| Condensate drain gasket, Ø25 | 1 pc |
| Installation manual | 1 pc |

3. SAFETY REQUIREMENTS

Carefully read and follow safety requirements provided below before installing and while operating the Unit:

- Do not discard the Installation and operation manual, keep it for future reference.
- The Unit should be installed and operated in compliance with this Installation and operation manual, following the requirements of effective legislation and standards.
- When connecting the Unit to mains supply, grounding must be installed in compliance with requirements of effective legislation and standards.
- To prevent accidents and potential damage to the Unit it should be installed, connected, maintained and repaired only by qualified technician. Never attempt to do this by yourself!
- Turn off the Unit by using Control panel and wait for fans to stop completely before replacing air filters.
- Turn off the Unit by using Control panel, wait for fans to stop completely and disconnect the Unit from mains supply before performing any maintenance.
- Disconnect the Unit from mains supply before disconnecting or reconnecting the control panel.
- Before connecting the Unit make sure that no items will get sucked into the its air intake openings!
- The Unit is not intended to be used by persons (including children) with reduced physical, sensory or mental capabilities, unless they have been instructed to use the Unit and under constant supervision of person held responsible for their safety.
- Children may only use the Unit under adult supervision.
- Only original supplementary parts and consumables, certified by manufacturer should be used.
- The Unit package (cardboard, plastic, foam polystyrene) can pose hazard to children. Dispose or recycle the package elements!
- Disused Unit should be disposed in accordance with requirements of legislation on handling of waste electrical and electronic equipment.
- **IT IS PROHIBITED** to operate the Unit with damaged mains supply cable! Switch off the power circuit-breaker to disconnect mains supply and contact a qualified technician or manufacturer service centre immediately upon noticing such damage.
- **IT IS PROHIBITED** to attempt the repair of the damaged Unit or its part, to open its cover! Contact a qualified technician or manufacturer service centre.
- **IT IS PROHIBITED** to operate the Unit while construction works are still in progress to remove dust or excess moisture. Fine dust of building materials, used in construction, can irreversibly change characteristics of the heat exchanger or cause damage to sensitive electronic components. Failure of the Unit caused by such operation will void the warranty.

4. EU DECLARATION OF CONFORMITY



We, undersigned below, representing the manufacturer of ventilation equipment:

Sviezias oras, JSC

Birzelio 23-osios g. 23G

50220 Kaunas

LITHUANIA

confirm, that heat recovery ventilation device **OXYGEN X-Air V500** conforms to Europe Union standarts, directives and regulations:

2009/125/EC – eco-design requirements for energy-related products

ES 1253/2014

ES 1254/2014

ES 2017/1369

EN 13141-7:2010

2010/30/EU – labelling and standard product information of the consumption of energy and other resources by energy-related products

ES 1254/2014

2011/65/EU – restriction of the use of certain hazardous substances in electrical and electronic equipment (RoHS)

EN 50581(2012)

2014/35/EU – harmonization of the laws of the Member States relating to the making available on the market of electrical equipment designed for use within certain voltage limits

EN 60335-1:2012

EN 60335-1:2012/A11:2014

CEO

Zilvinas Salialionis

01.02.2021, Kaunas

5. TECHNICAL DATA

5.1. Product information sheet. Delegated Regulation (EU) 1254/2014

| | | | |
|----|---|--|-------|
| a) | Supplier's name or trade mark | OXYGEN | |
| b) | Model identifier | X-Air V500 | |
| c) | Specific energy consumption (SEC), SEC class | A | |
| | Cold climate | kWh/m ² .a | -86.0 |
| | Average climate | kWh/m ² .a | -42.0 |
| | Warm climate | kWh/m ² .a | -16.9 |
| d) | Declared typology | Bi-directional, residential ventilation | |
| e) | Type of drive installed or intended to be | Variable speed drive | |
| f) | Type of heat recovery system | Recuperative | |
| g) | Thermal efficiency of heat recovery | % | 85.4 |
| h) | Maximum flow rate | m ³ /h | 500 |
| i) | Electric power input of the fan drive, including | W | 252 |
| j) | Sound power level (L _{WA}) | 53 | |
| k) | Reference flow rate | m ³ /s | 0.097 |
| l) | Reference pressure difference | Pa | 50 |
| m) | Specific power input (SPI) | W/(m ³ /h) | 0.30 |
| n) | Control factor | 0.65 | |
| | Control typology | Local demand control | |
| o) | Declared maximum leakage rate: | | |
| | internal | % | 1.2 |
| | external | % | 1.1 |
| q) | Position and description of visual filter warning | Refer to installation and operation manual | |
| s) | Internet address for pre-/dis-assembly | www.oxygenvent.com | |
| v) | The annual electricity consumption (AEC) | kWh/m ² .a | 1.6 |
| w) | The annual heating saved (AHS) | | |
| | Cold climate | kWh/a | 90.0 |
| | Average climate | kWh/a | 46.0 |
| | Warm climate | kWh/a | 20.8 |

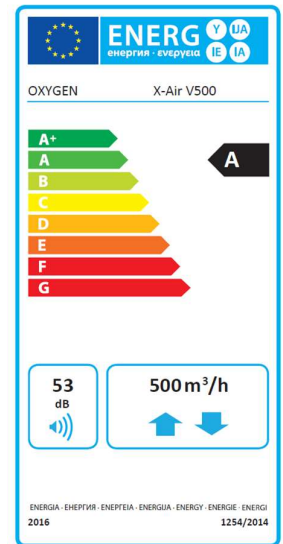

5.2. Performance curves

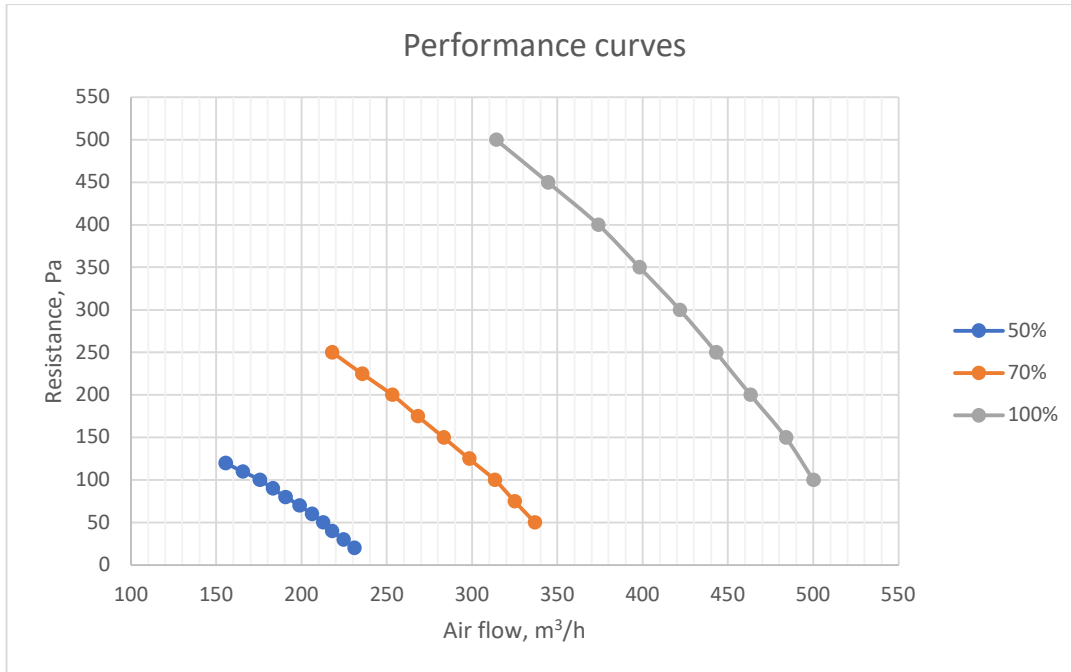

Graph. 1. Ventilation power dependence on the resistance of installed ventilation system

5.3. Performance and power consumption

| Power setting | Resistance, Pa | Air flow, m³/h | El. consumption, W |
|---------------|----------------|----------------|--------------------|
| 100% | 100 | 500 | 252.0 |
| | 150 | 484 | 251.6 |
| | 200 | 463 | 251.1 |
| | 250 | 443 | 249.9 |
| | 300 | 422 | 248.7 |
| | 350 | 398 | 247.4 |
| | 400 | 374 | 245.8 |
| | 450 | 344 | 242.5 |
| | 500 | 314 | 239.0 |
| 70% | 50 | 337 | 106.0 |
| | 75 | 325 | 105.8 |
| | 100 | 313 | 105.1 |
| | 125 | 298 | 104.9 |
| | 150 | 283 | 104.4 |
| | 175 | 268 | 104.0 |
| | 200 | 253 | 103.5 |
| | 225 | 236 | 102.8 |
| | 250 | 218 | 101.0 |

| | | | |
|-----|-----|-----|------|
| 50% | 20 | 231 | 49.0 |
| | 30 | 224 | 48.8 |
| | 40 | 218 | 48.5 |
| | 50 | 212 | 48.2 |
| | 60 | 206 | 47.8 |
| | 70 | 199 | 47.6 |
| | 80 | 191 | 47.3 |
| | 90 | 183 | 47.2 |
| | 100 | 176 | 46.9 |
| | 110 | 165 | 46.6 |

Measured with M5 class filters installed.

5.4. Sound characteristics

| Power setting | Air duct | Sound power level (L _{WA}) | | | | | | | |
|---------------|----------|--------------------------------------|-----|-----|------|------|------|------|-------|
| | | Octave band, Hz | | | | | | | Total |
| | | 125 | 250 | 500 | 1000 | 2000 | 4000 | 8000 | |
| 50% | Supply | | | | | | | | |
| | Extract | | | | | | | | |
| | Outside | | | | | | | | |
| | Exhaust | | | | | | | | |
| 70% | Supply | | | | | | | | |
| | Extract | | | | | | | | |
| | Outside | | | | | | | | |
| | Exhaust | | | | | | | | |
| 100% | Supply | | | | | | | | |
| | Extract | | | | | | | | |
| | Outside | | | | | | | | |
| | Exhaust | | | | | | | | |

Measured according to LST EN13141-7.

9.2. Dimensions and weight

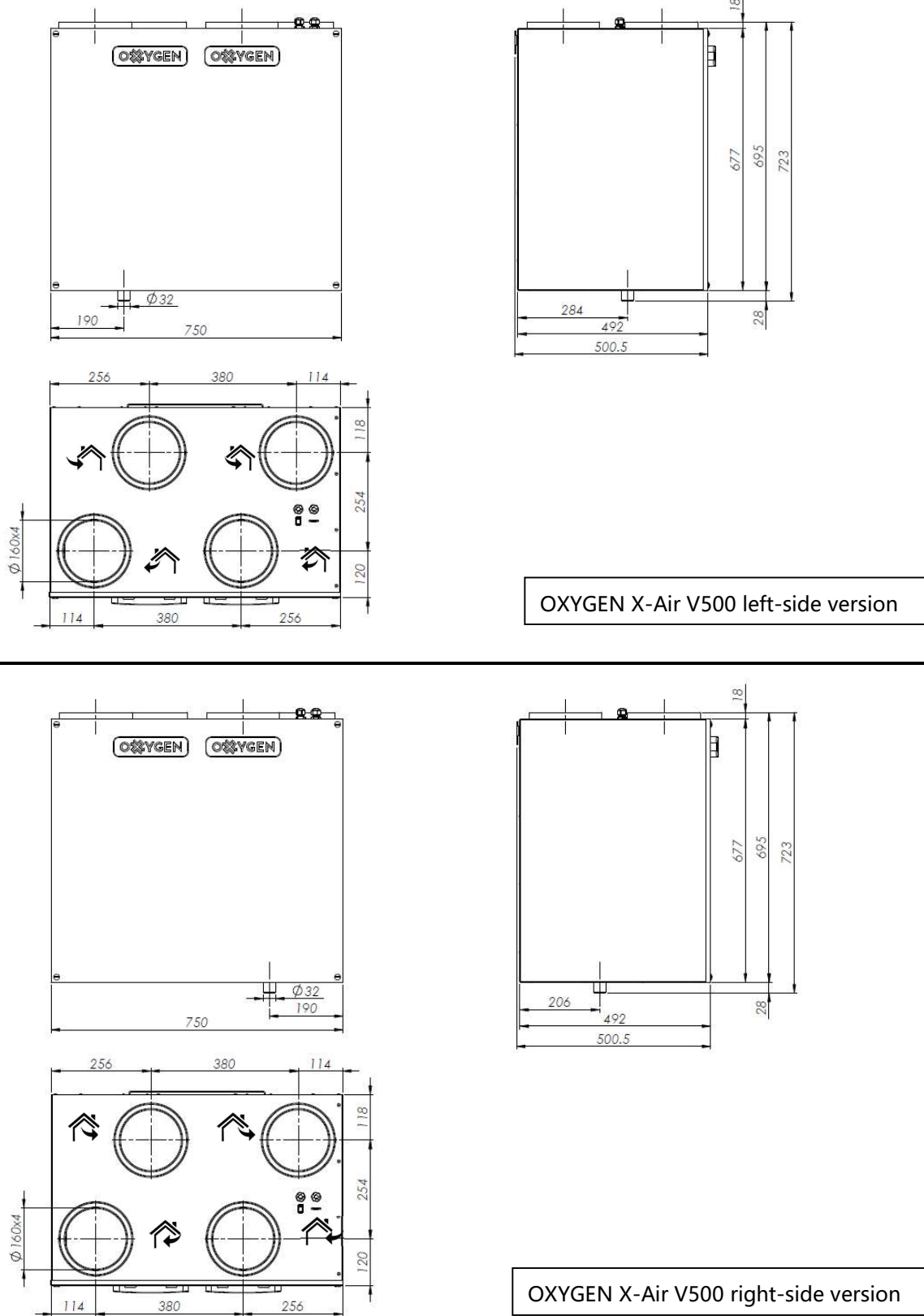

Figure 1. Unit dimensions

| Body dimensions and weight | Width, mm | Height, mm | Depth, mm | Weight, kg |
|----------------------------|-----------|------------|-----------|------------|
| OXYGEN X-Air V40 | 750 | 677 | 492 | 32 |

6. FUNCTIONALITY

| Function | Control panel with a rotary switch | LCD control panel / WiFi controller |
|--|------------------------------------|-------------------------------------|
| Ventilation | | |
| Efficient EC fans | | ✓ |
| Stepless ventilation intensity adjustment within 30-100% range | ✓ | ✓ |
| Ventilation intensity setting at 5% steps within 30-100% range | ✗ | ✗ |
| Weekly operation program, up to 4 different modes for every week day | ✗ | ✗ |
| Ventilation boost activation by control panel button | ✗ | ✗ |
| System balancing by adjusting power of each fan | | ✓ |
| Display of extract air temperature and relative air humidity | ✗ | ✗ |
| Display of date and time | ✗ | ✗ |
| Stepless increase of preheater power | | ✓ |
| Ventilation boost activation by external switch | | ✓ |
| "Away" - reduced ventilation power, when the security system is active | | ✓ |
| Adjustment of ventilation power according to CO2 level indoors | | ✓ * |
| Adjustment of ventilation power according to humidity level indoors | | ✓ * |
| Disabling of supply or exhaust air stream | ✗ | ✗ |
| Filtration | | |
| G4 (EN 779:2012) / COARSE 65% (ISO 16890), exhaust air filtering only | | ✓ |
| G4 Carbon (EN 779:2012) / EPM2.5 60% (ISO 16890), retains average size particles and unwanted odors | | ✓ |
| M5 (EN 779:2012) / EPM10 50% (ISO 16890), retains average size particles | | ✓ |
| F7 (EN 779:2012) / EPM1 70% (ISO 16890), retains smallest particles and pollen | | ✓ |
| Visual warning of the necessity to replace filters | | ✓ |
| Filter lifetime metering | | ✓ |
| Protection functions | | |
| Overheat protection | | ✓ |
| Anti-frost protection | | ✓ |
| Ventilation shutdown function upon activation of fire alarm | | ✓ * |
| Visual warning of the Unit failure | | ✓ |
| Additional functions / features | | |
| Possibility to install according to the layout of outdoor ventilation openings (right-side / left-side versions) | | ✓ ** |
| Control of electric damper | | ✓ ** |
| Control of in-duct comfort heater | | ✓ ** |

* requires additional ventilation system components to be purchased

** depends on device configuration, to be selected prior ordering the Unit and software version

7. INSTALLATION OF THE UNIT

7.1. Selecting the mounting location

The Unit should be installed in a heated room such as storage room, boiler room, garage or an attic. Make sure, that there is sufficient space to install not only the Unit itself, but also auxiliary ventilation system components – electrical heater, noise silencers or air distribution boxes. Make sure that there is a possibility to connect the condensate drain pipe of the Unit to the building's internal sewerage system.

Operating conditions: +15°C - +30°C, relative air humidity ≤ 60%.

The Unit should be installed vertically. Mounting bracket (provided) should be used to fasten Unit to the wall. Use wall pins or locking sleeves (not included), depending on installation surface. Use vibration isolation gaskets (not included) if necessary.

7.2. Connecting ducts

It is recommended to connect the indoor and outdoor air intake and exhaust ducts to the Unit by using couplings with rubber gaskets. It is necessary to seal the connection place well if any other type of connections is used.

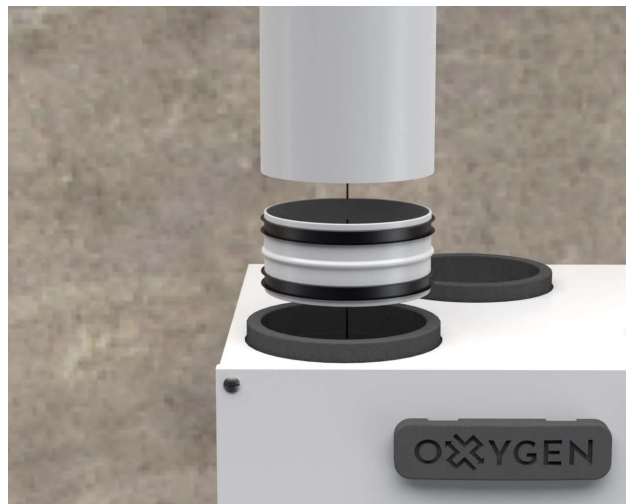

Figure 2. Air intake duct connection diagram

Make sure that outdoor humidity or precipitation will not get into the Unit, when connecting outside air supply and exhaust ducts. The air intake opening in the outside wall should be protected against precipitation ingress to ventilation duct by grille or roof.

It is recommended to install outside air supply and exhaust ducts as far as possible from each other to prevent the ingress of contaminated air back to premises. Please refer to local construction regulations.

IMPORTANT! Seal the air intake and exhaust ducts connection place well. Use couplings with rubber gaskets or other selected sealant.

IMPORTANT! At least 1° ventilation duct incline (refer to Figure 2. Air intake duct connection diagram) should be ensured or other sufficient measures taken to prevent ingress of outdoor humidity or precipitation into the Unit.

IMPORTANT! Both outside air intake and exhaust ducts and externally mounted preheater should be covered with a layer of thermal insulation of sufficient thickness to prevent condensation of humidity on their walls due to difference between outdoor and indoor air temperatures.

IMPORTANT! Avoid using duct grille with dense mesh – it can quickly become clogged with dust and will prevent fresh air supply. The Unit is equipped with supply air filter to trap dust and insects.

7.3. Maintenance space

When installing the Unit ensure sufficient space for its maintenance:

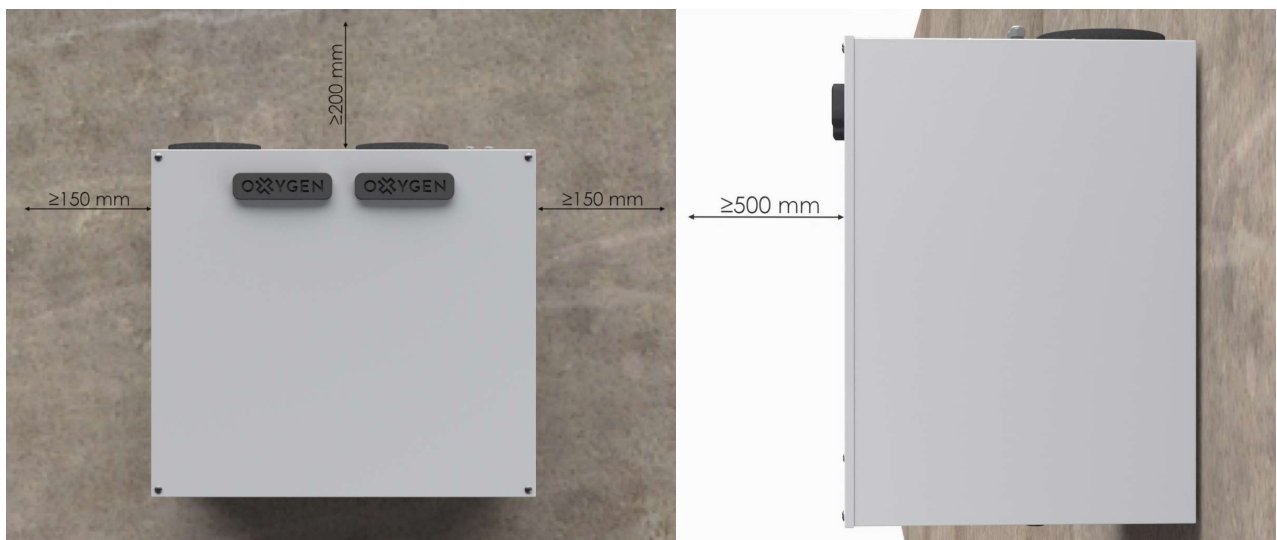

Figure 3. Maintenance space

- In front of the Unit 500 mm
- Above the Unit 200 mm

- Under the Unit:
 - when using HL138 type siphon 500 mm
 - when using HepVo type siphon 350 mm

IMPORTANT! Owner of the Unit shall ensure the possibility to perform Unit maintenance. If there is not enough space for Unit maintenance, the manufacturer's representative is entitled to refuse to perform maintenance or repairs.

7.4. Connecting the condensate drain

The Unit condensate drain should be connected to building's indoor sewerage system. If condensate drain is installed in non-heated premises or directed outdoors, it must be thermally insulated or equipped with electric heater.

Place a round rubber gasket on the condensate drain nozzle, then firmly screw the nozzle in by hand.



Figure 4. Installing the condensate drain

IMPORTANT! Do not use pliers or other similar tools, as excess power applied may damage the Unit. Mechanical damage will void the warranty.

The necessary incline of the condensate drain pipe should be ensured during the installation: at least 2° incline should be ensured in the horizontal part of the system, refer to Figure 5. Connecting the condensate drain.

Siphon with non-return valve is the obligatory part of the condensate drain system. It is recommended to use HL138, HepvO or similar type, internally or externally mounted siphon. Siphon should be installed according to Figure 5 diagram "Connecting the condensate drain", ensuring that the siphon manufacturer's instructions on incline, distances, necessary inspection hatch for the selected siphon model are observed.

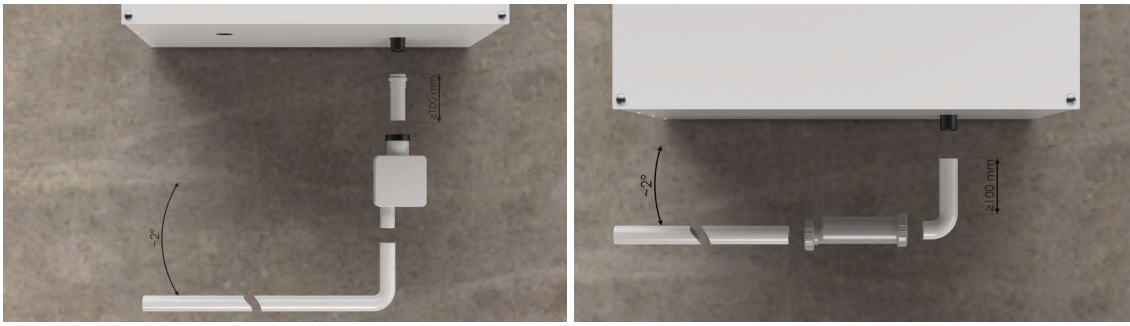

Figure 5. Connecting the condensate drain

IMPORTANT! Condensate will start accumulating within the Unit when dew-point conditions occur if necessary incline of condensate drain pipe is not observed or siphon with non-return valve is not installed or not functional. Excessive level of accumulated water can leak out through unexpected parts of Unit's body and can cause rust formation or damage walls or flooring. Operation of exhaust fan in conditions of excess moisture can cause its failure. Failure to properly install condensate drain will void the warranty.

7.5. Ventilation system balancing

It is necessary to balance the supply and exhaust air flows of the air handling unit during first launch of the ventilation system. Ventilation system will ensure proper heat recovery and the lowest possible electricity consumption during the cold season only if properly balanced.

System has to be balanced according to ventilation system installation project. Balance the supply and exhaust air flows by adjusting values for Fan1 and Fan2 in the operating parameters setting menu of control panel with touchscreen display (refer to section 1.5 of Operating parameters setting manual) or using P3 and P4 controls of control panel with the knob (refer to section 9.3.6 "Additional system settings").

There is a risk of heat exchanger freezing when operating an unbalanced ventilation system during the cold season, as a result of which air handling unit may start supplying cold air to the premises. Unexpected indoor air moisture condensation can occur on the supply air ducts.

IMPORTANT! Balancing of the system can only be entrusted to qualified professional possessing all the necessary properly calibrated technical equipment.

IMPORTANT! Request a ventilation system passport to be prepared.

IMPORTANT! Freezing of heat exchanger which occurred during operation of an unbalanced ventilation system can irreversibly change the properties of the heat exchanger and damage the internal air tightness of the Unit. Failure of the Unit due to freezing while operating the unbalanced ventilation system will void the warranty!

8. CONNECTION OF THE UNIT

Mains supply, control panel cable and, if necessary, comfort function connector should be connected to the Unit, according to the following diagram:

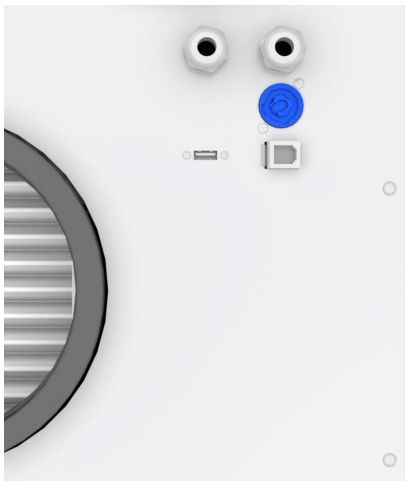

- Mains cable (230V, 3x1.5mm² L+N+PE)
- el. preheater cable (*1) (230V, 3x1.5mm² L+N+PE)
- el. heater cable (*2) (230V, 3x1.5mm² L+N+PE)
- el. damper actuator (*3) connector
- control panel or WiFi controller connector (USB)
- comfort functions connector (RJ-45)

Figure 6. Connection of the Unit

IMPORTANT! Number and purpose of connections depends on device configuration:

*1 – if internal preheater is not present

*2 – if option selected prior ordering the Unit

*3 – if option selected prior ordering the Unit

IT IS PROHIBITED to connect any cables or devices to the connectors of the control panel and comfort functions, despite similarity to any standard connectors. External similarity of connectors does not guarantee compatibility – connected devices may fail or damage the Unit. Failure of the Unit due to incompatible supplementary parts connection will void the warranty!

IT IS PROHIBITED to connect or disconnect control panel or WiFi controller without turning off the mains power first. The failure of the control panel or the Unit due to improper connection will void the warranty!

8.1. Connecting electric circuit

WARNING!!!

- To prevent accidents and potential damage to the Unit, it can only be connected by a qualified technician. Do not attempt to do that by yourself!
- Mains supply power rating shall comply with the rating indicated in the Unit manual.
- Mains supply should be disconnected when connecting the Unit.
- The Unit should be connected according to diagram provided in the User Manual.
- Only power cable provided with the Unit should be used to connect it to power source.
- Grounding should be installed in compliance with the requirements of effective legislation and standards when connecting the Unit to mains supply.
- Electric circuit must be equipped with suitable power circuit-breaker.

| | |
|--|----------------|
| Power supply | 230V, 50Hz, 5A |
| Maximum electric power consumption – fans | 252W |
| Maximum electric power consumption – preheater | 3000W |
| Maximum electric power consumption – heater | 3000W |
| IP protection class | 20 |

8.2. Installation of the control panel

It is recommended to install control panel of the Unit in a living space (for example, in a corridor or hall) at 1.5 – 1.6 m height from the floor for convenient access. Lay the control panel connection cable supplied from the Unit location to the control panel location before finishing decoration works.

The maximum permissible installation distance of control panel from the Unit is 100 m. Use a flexible mounting cable 4x0.22mm² to connect the panel, the resistance of each conductor must not exceed 40Ω.

IT IS PROHIBITED to install control panel in premises, where relative air humidity exceeds 70%.

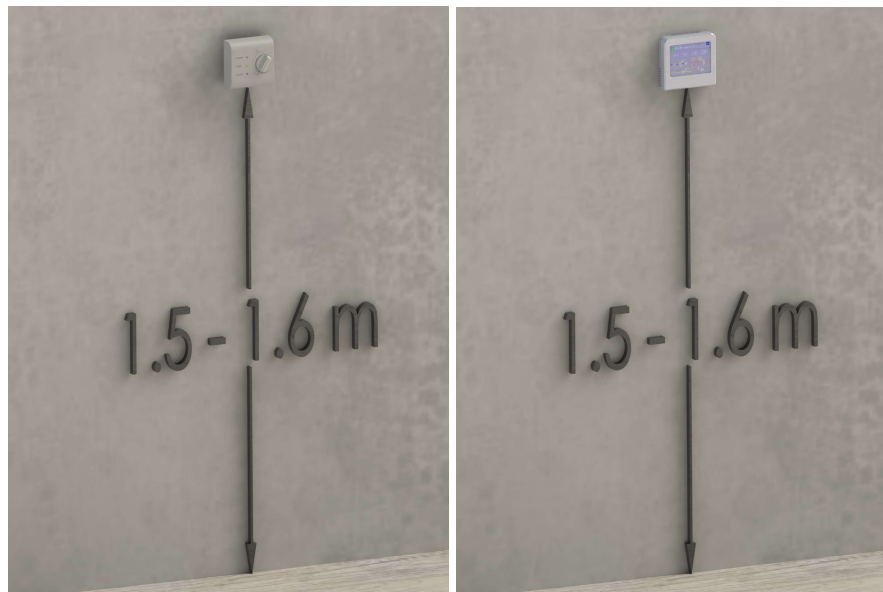

Figure 7. Installation of the control panel

8.3. Connector of comfort functions

The Unit supports following external functionality:

- **Fire alarm** – emergency shutdown of the Unit upon activation of fire alarm;
- **Boost** – ventilation boost activation by external switch;
- **CO₂ sensor** – ventilation power increase based on readings of auxiliary CO₂ or humidity sensors connected;
- **Away** – reduction of ventilation power while away from home by security system or external switch.

Function can be activated by short circuiting the respective digital contacts of RJ45 function connector.

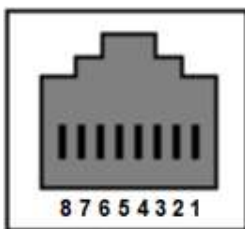

| Conn. contact No. | Function of ventilation system |
|-------------------|--------------------------------|
| 1-2 | Away |
| 3-4 | CO ₂ sensor |
| 5-6 | Boost |
| 7-8 | Fire alarm |

Figure 8. Contacts of functions connector

IMPORTANT! Only passive jumpers or electric relays should be used to activate the function!

IMPORTANT! If the Unit is being controlled by control panel with a knob, please make sure that corresponding S2 switch does not block the usage of function (refer to section 9.3.6 "Additional system settings").

IT IS PROHIBITED to connect the functions connector directly to electrical wiring network!

Optional RJ45 adapter can be used for more convenient connection:



Figure 9. Comfort functions RJ45 connector adapter

8.4. Control board electrical wiring diagram

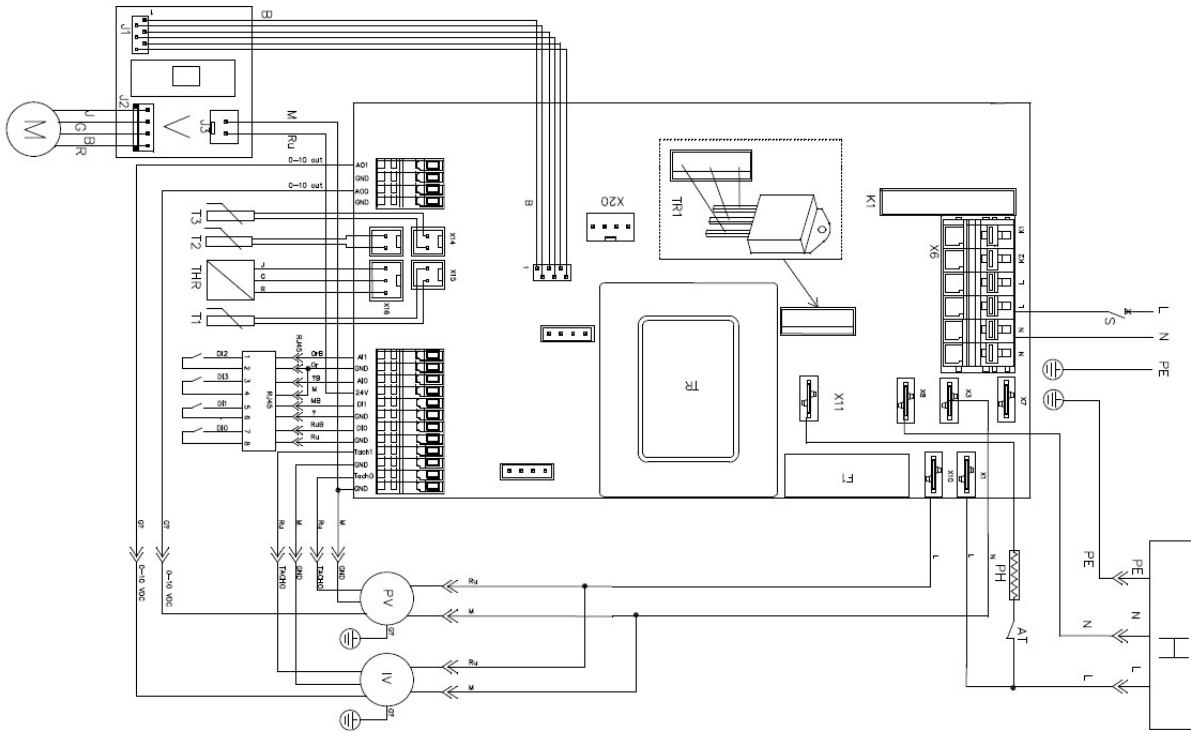

Figure 10. Control board electrical wiring diagram

IMPORTANT! Make sure that the Unit is disconnected from mains supply before connecting or disconnecting system components.

8.5. Description of control board contacts

| | |
|-------|--|
| AO1 | Exhaust fan control 0-10V |
| GND | Not used |
| AO0 | Supply fan control 0-10V |
| GND | Not used |
| X13 | Exhaust air temperature sensor |
| X14 | Supply air temperature sensor |
| X15 | Outside air temperature sensor |
| X16 | Extract air temperature/ humidity sensor |
| AI1 | DI2 function – "Away" |
| GND | |
| AI0 | DI3 function – "CO2 sensor" |
| 24V | Not used |
| DI1 | DI1 function – "Boost" |
| GND | |
| DI0 | DI0 function – "Fire alarm" |
| GND | |
| Tach1 | Exhaust fan tachometer signal |
| GND | |
| Tach0 | Supply fan tachometer signal |
| GND | |
| X20 | Control Panel connector |
| X1 | Exhaust air fan L |
| X3 | Exhaust and Supply fans N |
| X7 | Preheater L |
| X10 | Supply fan L |
| X11 | Preheater N |
| K1 | Bypass N |
| K2 | Not used |
| L | Bypass L |
| L | Mains L |
| N | Mains N |
| N | Not used |
| F1 | 315mA fuse |
| B | Bypass control data connection |
| J3 | Bypass power 24V |

9. OPERATION OF THE UNIT

9.1. WiFi controller

You may control the Unit by app installed on smartphone or tablet by purchasing the WiFi controller.



Figure 11. WiFi controller

IT IS PROHIBITED to connect or disconnect WiFi controller while the Unit is powered. Failure of the Unit or WiFi controller caused by improper connection will void the warranty.

9.1.1. Downloading the app

Download the OXYGEN WiFi app for your smartphone or tablet from the App store or Google Play store:



By downloading or using the app or WiFi controller, you agree that Sviezias oras, JSC collects and processes air handling unit usage data as described in the privacy policy <https://www.oxygen.lt/privacy-policy-gdpr-en/>.

9.1.2. WiFi connection set-up

Plug in the WiFi controller then power-up the Unit. Connect WiFi controller to your home WiFi network first:

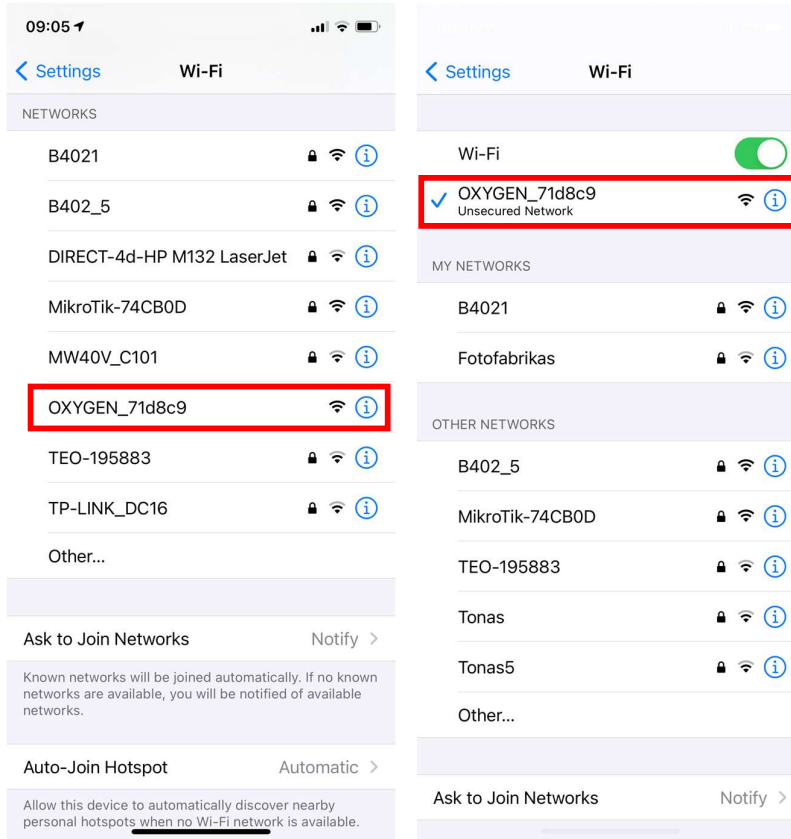

Figure 12. WiFi connection set-up

- Locate and connect to unprotected WiFi network OXYGEN_XXXXXX

IMPORTANT! WiFi controller will only broadcast unprotected WiFi network for 2 minutes. If You fail to connect while it is active, broadcasting will stop. Slightly press and release immediately the hidden button through the small hole on WiFi controller body with thin screwdriver (safety-match, toothpick) to restart broadcasting.

IMPORTANT! In case of home WiFi network device (router or ADSL modem) failure or any other failure to properly configure WiFi controller, the broadcasting of secure WiFi network OXYGEN_XXXXXX may start. Connect to it using standard system password 123123123123.

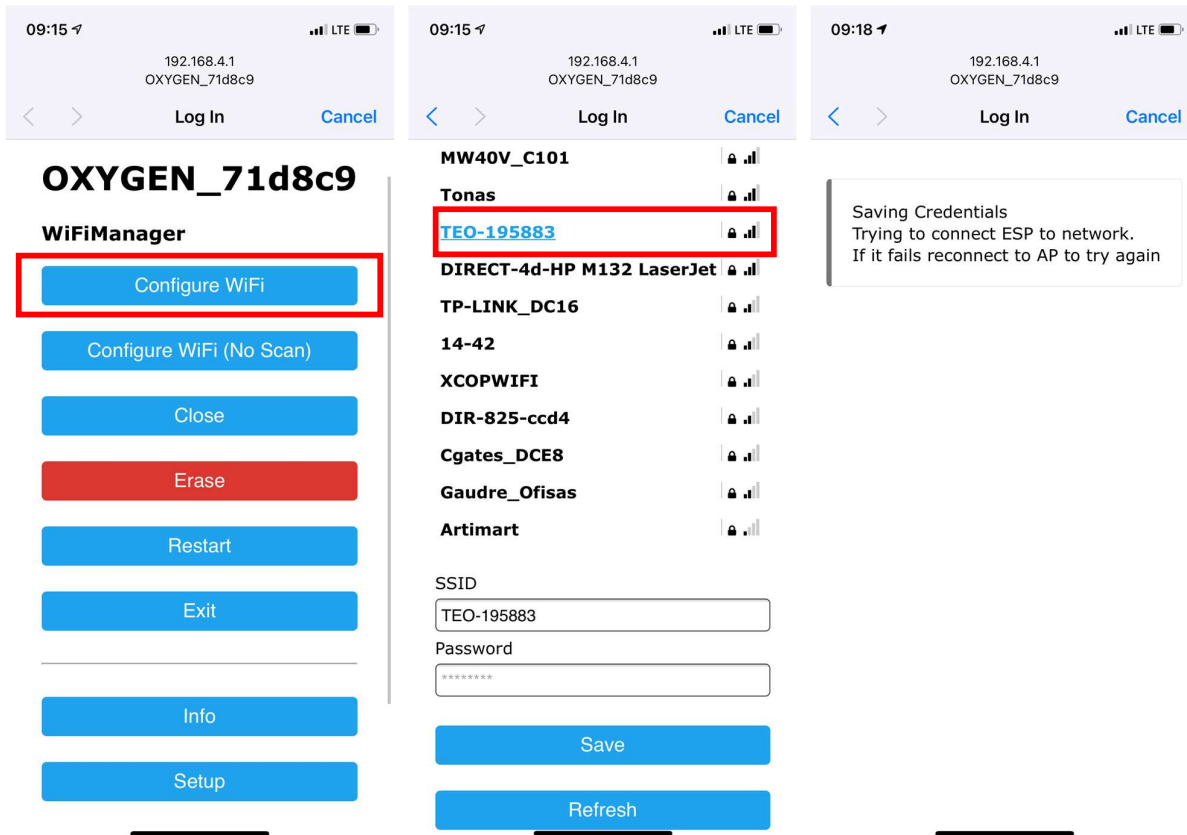

Figure 13. WiFi connection set-up

- WiFi Manager window will pop up after succesfull connection
- click "Configure WiFi" button
- locate and select your home WiFi network in the list
- enter your home WiFi network connection password
- click "Save"

WiFi controller will connect to your home WiFi network after accomplishing all tasks

IMPORTANT! In case (usually due to smartphone or tablet security settings) WiFi Manager window does not pop up, connect to WiFi Manager console using browser (Safari, Chrome or similar) by entering 192.168.4.1 in the address field. Make sure that your device (smartphone or tablet) is connected to OXYGEN_xxxxxx WiFi network (you may be asked to confirm connection by hitting "use without internet" or similar button).

IMPORTANT! If it is necessary to control the Unit without connecting it to home WiFi network, change the standard system password immediately. Change it by connecting to management console using browser. Broadcasting of secure WiFi network OXYGEN_xxxxxxs will then become permanent.

IMPORTANT! App will only access the Unit if both WiFi controller and device are connected to the same home WiFi network.

9.1.3. App home screen

Home screen of control app:

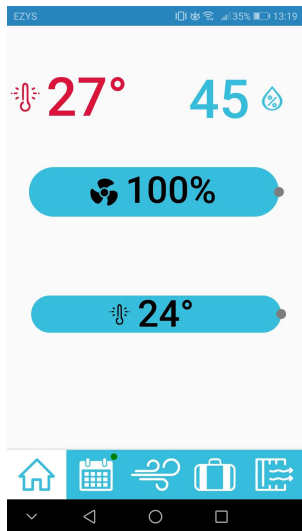

- inside air temperature and relative humidity
- set the desired ventilation intensity
- set the desired room air temperature by maintaining supply air flow temperature* or controlling external heating device**

* availability of feature depends on device configuration, to be selected prior ordering the Unit

** requires additional ventilation system components to be purchased

Figure 14. Home screen of control app

9.1.4. Setting up weekly operation program

Up to 4 different ventilation modes can be set for each day of week. Set the desired operation program for the selected day or days of the week:

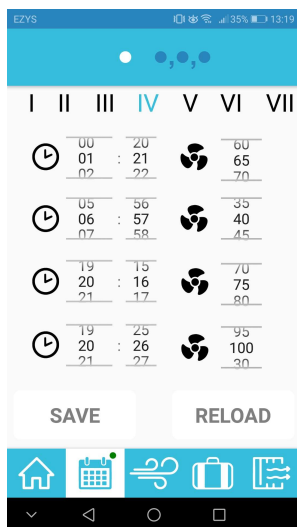

- select single or multiple week days
- select day or days depending on above selection
- set operating mode start time and ventilation intensity for each slot
- click "SAVE" to apply or "RELOAD" to discard changes

Figure 15. Setting up weekly operation program

IMPORTANT! Activate weekly operation program by double-clicking calendar icon on menu ribbon, green dot will appear. Deactivate by double-clicking icon again, green dot will disappear.

9.1.5. Ventilation boost activation

Activate selected (increased) ventilation intensity for selected time:

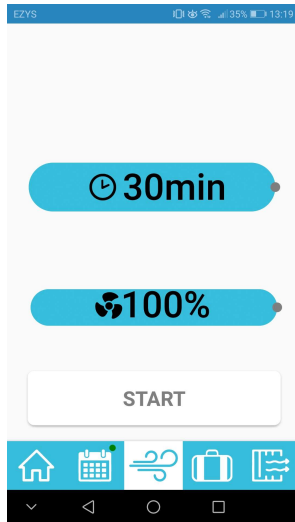

- set time of operation
- set ventilation intensity
- activate selected ventilation intensity by clicking "START"

Figure 16. Ventilation boost activation

After the selected time, previously set or scheduled ventilation intensity will be activated.

9.1.6. Away

Activate selected (decreased) ventilation intensity until the selected date. The feature is useful when leaving home for a weekend or vacation:

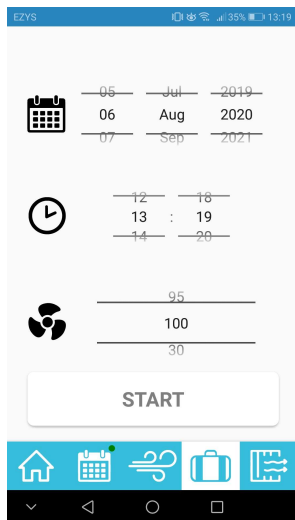

- select return date
- select return time
-
- select ventilation intensity
-
- activate selected (decreased) ventilation intensity by clicking "START"

Figure 17. Away

9.1.7. Filter menu

Set the type of filters used, monitor filter lifetime, reset filter usage timer:

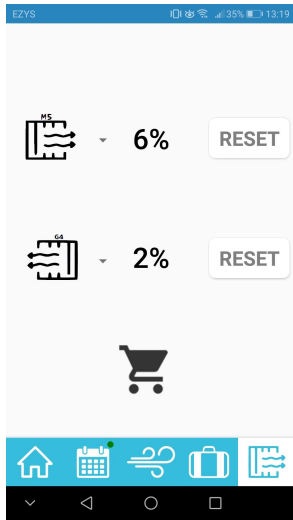

- select the type of supply air filter by clicking on the filter icon
- reset supply filter usage timer by clicking "RESET" button
- select the type of exhaust air filter by clicking on the filter icon
- reset exhaust filter usage timer by clicking "RESET" button
- order replacement filter set by clicking trolley icon

Figure 18. Filter menu

9.1.8. Resetting WiFi controller to factory defaults

If it is necessary to reset WiFi controller to factory defaults, click and hold the hidden button through the small hole of WiFi controller body with thin screwdriver (safety-match, toothpick) until the yellow light will fade away.

You will have to reconnect WiFi controller to your home WiFi network to regain ability to control the Unit, refer to section 9.1.2 "WiFi connection set-up").

9.2. Control panel with touchscreen display

Control panel with touchscreen display screen makes it possible to use the enhanced Unit functionality.



Figure 19. Control panel with touchscreen display

9.2.1. Standby mode

Touchscreen display of control panel will only display the time of day in standby mode if the Unit is switched off. If the Unit is in operation, settings of desired temperature and ventilation intensity will also be displayed.



Figure 20. Control panel with touchscreen display in standby mode: the Unit is switched off, the Unit is in operation

9.2.2. Main screen

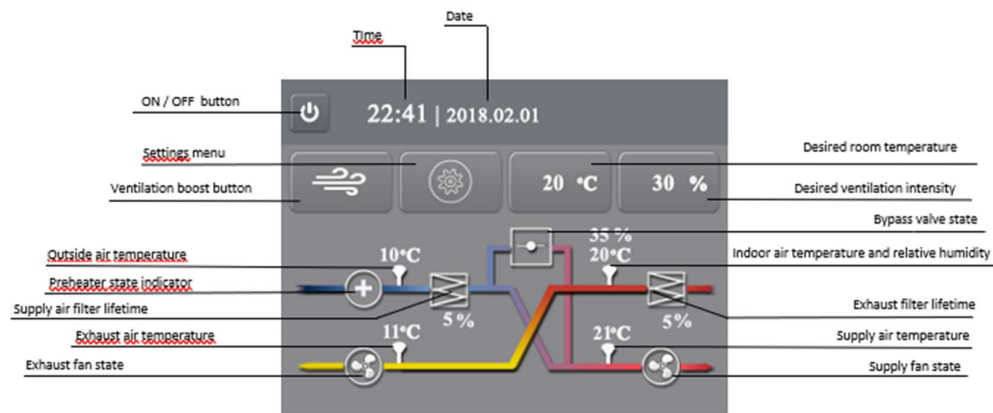



Figure 21. Main screen of control panel with touchscreen display

Main screen displays:

- Time of day
- Date
- Temperatures:
 - Outside* air (refer to section 9.2.2.1 "Winter mode")
 - Extract air
 - Supply air
 - Exhaust air
- Relative humidity of extract air
- Lifetime of supply and exhaust air filters
- Bypass valve state (depends on device configuration)
- Preheater state

This menu enables to:

- Activate the "boost" mode by single touch of  button
- Access the settings menu
- Set the desired room air temperature
- Set the desired ventilation intensity

9.2.2.1. Winter mode

Outside* air temperature display depends on ambient conditions:

- If outside air temperature is above 0° C, the outside air temperature is being displayed;
- If outside air temperature is below 0° C and preheater is on, the temperature after preheater is being displayed.

Preheater state:

| | |
|---------------|---------------------------------|
| preheater on | green ⊕ sign is being displayed |
| preheater off | white ⊕ sign is being displayed |

IMPORTANT! Higher than usual electricity consumption is expected when preheater is on!

9.2.2.2. Maintaining the desired room air temperature

You may set the desired room air temperature from the control panel menu. In the cold season, air supplied to the room can be additionally heated by a separately purchased duct heater installed in the ventilation system.

IMPORTANT! Availability of feature depends on device configuration, to be selected prior ordering the Unit.

9.2.3. Settings menu

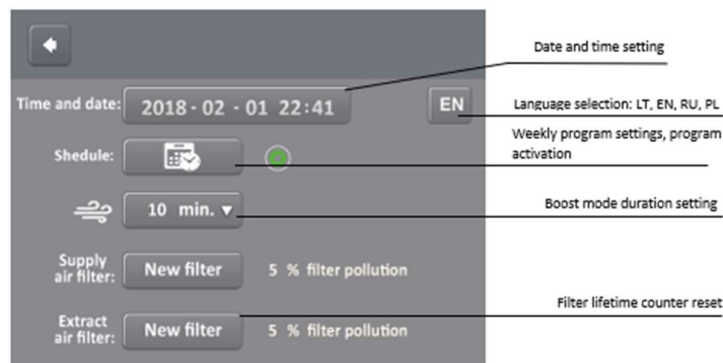

Figure 22. Settings menu

Control panel settings menu enables to:

- Set system date and time
- Select menu language: English, Russian, Polish, Lithuanian
- Set up weekly operation program
- Set duration of boost mode
- Reset filter lifetime counters after replacing air filters

9.2.4. Setting up weekly operation program

Up to 4 different ventilation modes can be set for each day of week. After selecting the week day, set:

- operating mode start time
- selected ventilation intensity
- desired room air temperature



Figure 23. Weekly operating mode settings menu

Weekly operation program will be saved by clicking "back arrow" button.

IMPORTANT! Click on the round button next to schedule button in main menu to activate a weekly operation program. Green color of button means the program is active. Toggle to deactivate.

9.2.5. Failure indication

In case of Unit component failure, the RESET button will appear in main menu. Failed component icon will turn red, Unit operation will stop.

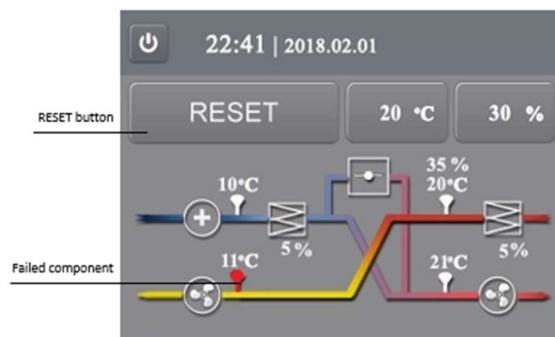

Figure 24. Failure indication

Press the RESET button. The Unit will restart and if the failure was resolved, will continue to operate. If the problem with failed component will persist after the Unit reset procedure has been performed and RESET button will reappear, contact manufacturer of the Unit or its local representative.

You may control the Unit by app installed on smartphone or tablet by purchasing the WiFi controller.

9.3. Control panel with a knob

Control panel with a knob makes it possible to gradually control the ventilation intensity. Colored LEDs indicate status of the Unit.

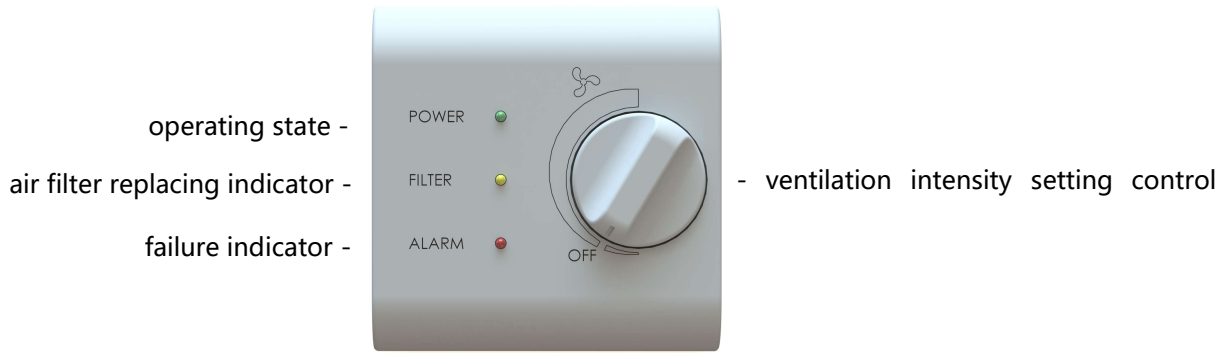

Figure 25. Control panel with a knob

9.3.1. Operating state indicator

Flashing green led indicates that the Unit is connected to power supply:

| | |
|-----------------|---------------------------|
| flashes 1 time | ventilation is off |
| flashes 2 times | ventilation is on |
| flashes 3 times | the Unit is shutting down |

9.3.2. Air filter replacing / anti-frost protection indicator

Flashing yellow led indicates:

| | |
|--------------------------------------|------------------------------------|
| flashing consistently | it is necessary to replace filters |
| yellow and green leds flash in turns | anti-frost protection is on |

Control panel indicates the necessity to replace filters after 6 months of uninterrupted Unit operation by consistent flashing of yellow led. Disconnection of the Unit from mains supply does not reset the counter.

During cold season of a year green and yellow leds flashing in turns indicate that anti-frost protection has been activated, the electric preheater is on.

IMPORTANT! Filters may need to be replaced more frequently – refer to section 9.4 "Replacing air filters".

IMPORTANT! Higher than usually power consumption is to be expected when the Unit is operating in this mode.

9.3.3. Failure indicator

The flashing red led indicates that failure of the Unit component was detected:

| | |
|--|--|
| flashes 1 time | failure of outside air temperature sensor |
| flashes 2 times | failure of exhaust air temperature sensor |
| flashes 3 times | failure of supply air temperature sensor |
| flashes 4 times | failure of extract air temperature sensor |
| flashes 5 times | failure of supply fan motor |
| flashes 6 times | failure of exhaust fan motor |
| flashes 7 times | fire alarm has been activated |
| flashes 8 times | failure of preheater |
| both red and yellow leds are on (no flashing) | connection between control panel and the Unit was lost and the Unit is operating in safe mode |

Unit operation will stop after detecting component failure. You can restart the Unit by following RESET procedure:

9.3.4. RESET procedure

Gently press and release the hidden button S1 through the small hole on the side of control panel with thin screwdriver (safety-match, toothpick) twice, until all three color leds switch on. Then immediately press and hold S1 button again for about 3 seconds, until all leds switch off.

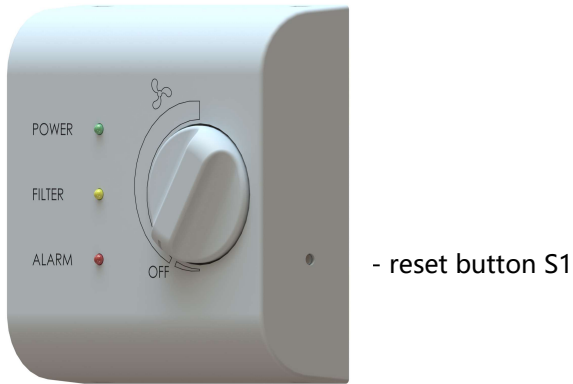

Figure 26. Reset button

IMPORTANT! If red failure indicator led starts flashing again after the Unit reset procedure has been performed, contact manufacturer of the Unit or its local representative.

9.3.5. Resetting the filter lifetime meter

Filter lifetime meter has to be reset after air filters have been replaced.

Gently press and release the hidden button through the small hole on the side of control panel S1 with thin screwdriver (safety-match, toothpick), making the yellow led switch on. Then immediately press and hold S1 button again for about 3 seconds, until led fades away.

IMPORTANT! Resetting the air handling unit (refer to section 9.3.4 "RESET procedure") does not reset filter lifetime meter.

9.3.6. Additional system settings

Controllers for additional settings of ventilation system are installed inside the control panel:

| | |
|----|--|
| P1 | boost mode time setting |
| P2 | boost mode power setting |
| P3 | supply fan power adjustment |
| P4 | exhaust fan power adjustment |
| S1 | reset button |
| S2 | switches for disabling (OFF) or activating (ON) boost (1) and away (2) functions |

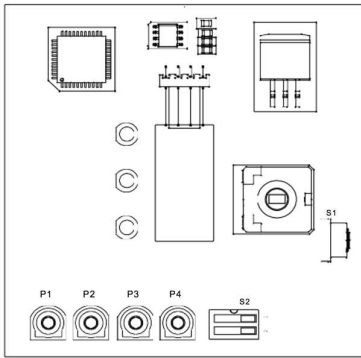

Figure 27. Additional settings for control panel with a knob

You may control the Unit by app installed on smartphone or tablet by purchasing the WiFi controller.

9.4. Replacing air filters

Heat Recovery Unit OXYGEN X-Air V500 is equipped with supply and exhaust air filters.

- **Supply air filter** ensures supply air quality, protects against ingress of outdoor dust and insects (G4 Carbon, M5, F7 filtering classes);
- **Exhaust air filter** protects the device against ingress of indoor dust and insects (G4 filtration class).
-

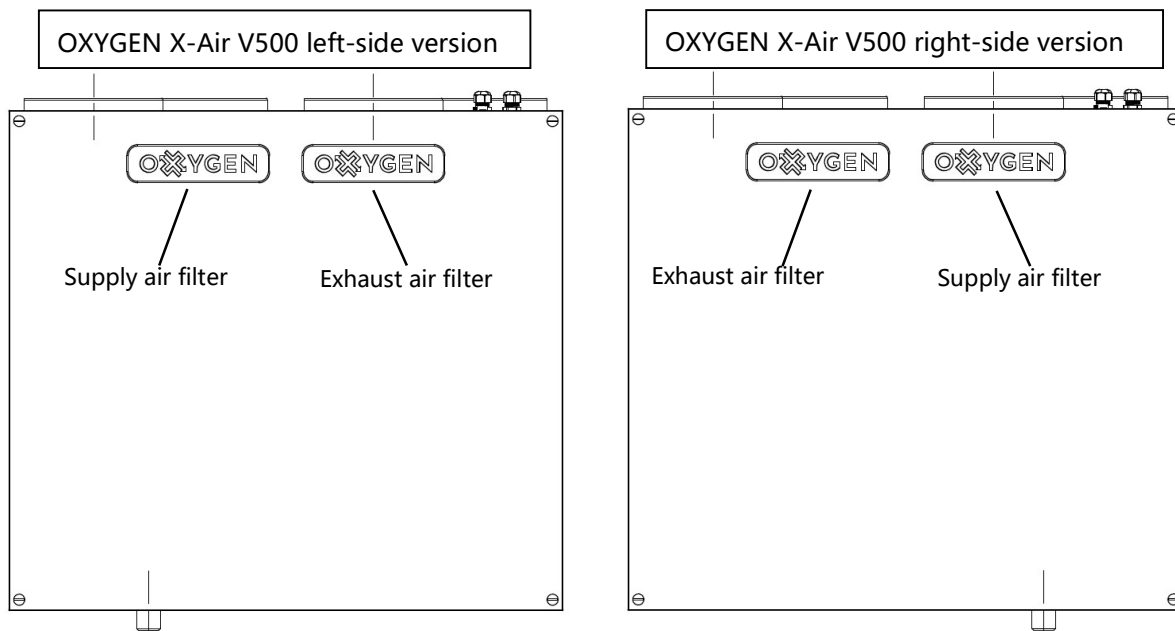

Figure 28. Locating air filters

Air filter replacing frequency depends on the selected filtering class and environment, where the Unit is being operated. Dusty operation environment will foul filters faster.

Replacing air filters:

- Shut down the Unit by control panel, make sure that fans have completely stopped
- Open the lid of the filter, that you intend to change, marked by "OXYGEN" by firmly gripping it and pulling out
- Use fabric handle to remove a filter
- Insert a new filter, following ventilation flow direction indicated on filter frame – it should point downwards
- Firmly push the lid of the filter back to its place. Make sure it was tightly inserted into the Unit housing
- Turn on the Unit
- Reset filter lifetime meter, refer to 9.3.5 "Resetting the filter lifetime meter" or 9.2.3 "Settings menu", depending on type of controller used.

It is recommended to replace air filters at least:

| Filtering class, acc. EN 779:2012 | Filtering class, acc. ISO 16890 | Recommended replacing frequency |
|--------------------------------------|------------------------------------|---------------------------------|
| G4 | Coarse 65% | every 6 months |
| G4 Carbon | ePM _{2.5} 60% | every 4 months |
| M5 | ePM ₁₀ 55% | every 4 months |
| F7 | ePM ₁ 70% | every 2 months |

IMPORTANT! The fouled air filters can result in ventilation power decrease and higher than usually power consumption.

IMPORTANT! Only original, manufacturer recommended filters should be used. The use of low quality third party filters can result in damage to sensitive device components due to excess dust or humidity. Metal filter frames can cause unrestorable damage to Units body. Failure of the Unit caused by the use of non-original components, will void the warranty.

Replacement filters can be ordered at: www.oxygenvent.com.

10. MAINTENANCE AND WARRANTY

Heat recovery Unit OXYGEN X-Air V500 is granted 24 months warranty. Make sure to have the section below properly filled in to confirm the installation date. Have the proof of purchase handy before contacting service department.

Product OXYGEN X-Air V500

Serial No. _____

Installation date _____

Contractor (company) _____

(company name, technician, signature, stamp, contact details)

IMPORTANT! Before contacting service department, make sure that the failure is persistent – check that:

- The Unit is connected to mains supply
- Power circuit-breaker is ON
- If RESET button is being displayed on touchscreen control panel (refer to section 9.2.5 "Failure indication") or flashing red led of control panel with a knob indicates failure (refer to section 9.3.3 "Failure indicator"), try rebooting the Unit first.

IMPORTANT! Flashing green and/or yellow leds of control panel with a knob do not indicate the failure! Refer to section 9.3.2 "Air filter replacing / anti-frost protection indicator" for more information.

Prepare to submit :

- Product model and serial number (locate it on the product label)
- Proof of purchase, including invoice or receipt
- Detailed description of failure, including photos or video recordings of the Unit, control panel and place of installation if necessary
- Your name, address, contact phone number, e-mail address

After gathering all the necessary information, contact the point of purchase.

11. CONTACTS

OXYGEN group, JSC

Company code: 304288834

VAT code: LT100010366918

Bank account: LT42 7044 0600 0810 3886

SWIFT: CBVILT2X

AB "SEB" bank

Address: Birzelio 23-osios g. 29

50201 Kaunas

Lithuania

www.oxygenvent.com